



2 Matrix Otto

3 Matrix Quattro

4 Matrix Doppia

5 Matrix Bulbs

Matrix Otto

Designer

Yaacov Kaufman - 2000

Hanging lamp in aluminium alloy and steel made out of a central body with eight arms that can be moved vertically; halogen or fluorescent compact bulbs can be used within the maximum admitted power.

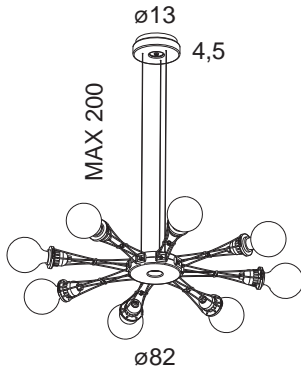

Denominazione - Name - Name **Matrix Otto (cod. 385)**

Certificazioni - Certificates - Prüfzeichen **CE**

Normative - Norms - Normen **EN 60-598-1 (CEI 34-21)**

Lampadina - Light sources - Leuchtmittel **8 x MAX 75W I/HAL - 21W FL EL - E27/E26 (not included)**

Versioni - Available - Versionen **230V (Europe) - 120V (USA - Japan) - 240V (England)**

Classe di isolamento - Insulation Class - Isolierungsklasse **I**

Classe di protezione - Protection Class - Protektionsgrad **IP20**

Imballo - Packaging - Verpackung **0,058m³ - 4,0Kg**



Col. 01
Nero
Black
Schwarz



Col. 07
Grigio metallizzato
Metallic grey
Metallic grau



Col. 44
Nichelato
Nickled
Vernickelt

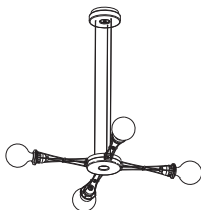

Cod. 386
Matrix Quattro

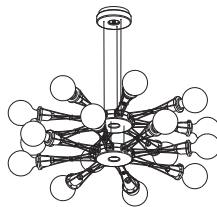

Cod. 387
Matrix Doppia

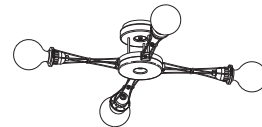

Cod. 388
Matrix Quattro/P

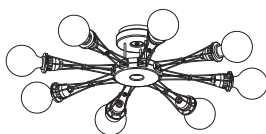

Cod. 389
Matrix Otto/P



Cod. 393 - 394
Matrix Terra

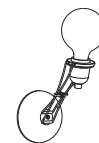

Cod. 395 - 396
Matrix Mono - Matrix Mono/I

Matrix Quattro

Designer

Yaacov Kaufman - 2000

Hanging lamp in aluminium alloy and steel made out of a central body with four arms that can be moved vertically; halogen or fluorescent compact bulbs can be used within the maximum admitted power.

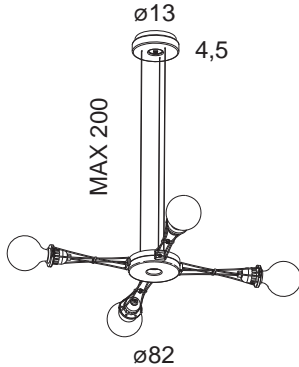

Denominazione - Name - Name **Matrix Quattro (cod. 386)**

Certificazioni - Certificates - Prüfzeichen **CE**

Normative - Norms - Normen **EN 60-598-1 (CEI 34-21)**

Lampadina - Light sources - Leuchtmittel **4 x MAX 75W I/HAL - 21W FL EL - E27/E26 (not included)**

Versioni - Available - Versionen **230V (Europe) - 120V (USA - Japan) - 240V (England)**

Classe di isolamento - Insulation Class - Isolierungsklasse **I**

Classe di protezione - Protection Class - Protektionsgrad **IP20**

Imballo - Packaging - Verpackung **0,058m³ - 3,2Kg**



Col. 01
Nero
Black
Schwarz



Col. 07
Grigio metallizzato
Metallic grey
Metallic grau



Col. 44
Nichelato
Nickled
Vernickelt

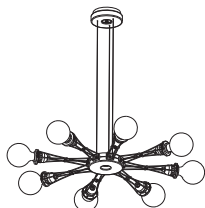

Cod. 385
Matrix Otto

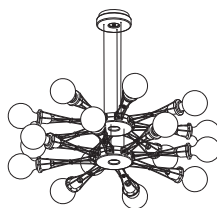

Cod. 387
Matrix Doppia

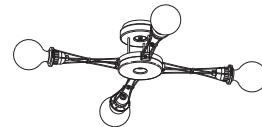

Cod. 388
Matrix Quattro/P

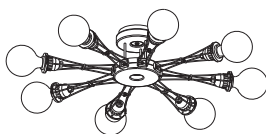

Cod. 389
Matrix Otto/P



Cod. 393 - 394
Matrix Terra

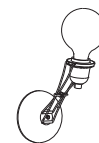

Cod. 395 - 396
Matrix Mono - Matrix Mono/I

Matrix Doppia

Designer

Yaacov Kaufman - 2000

Hanging lamp in aluminium alloy and steel made out of a central body with sixteen arms that can be moved vertically; halogen or fluorescent compact bulbs can be used within the maximum admitted power.

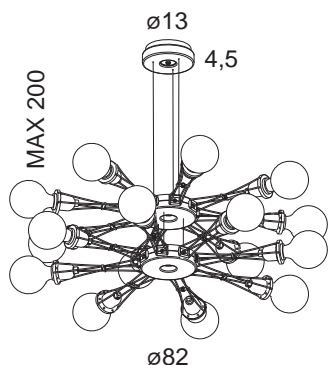

Denominazione - Name - Name **Matrix Doppia (cod. 387)**

Certificazioni - Certificates - Prüfzeichen **CE**

Normative - Norms - Normen **EN 60-598-1 (CEI 34-21)**

Lampadina - Light sources - Leuchtmittel **16 x MAX 75W I/HAL - 21W FL EL - E27/E26 (not included)**

Versioni - Available - Versionen **230V (Europe) - 120V (USA - Japan) - 240V (England)**

Classe di isolamento - Insulation Class - Isolierungsklasse **I**

Classe di protezione - Protection Class - Protektionsgrad **IP20**

Imballo - Packaging - Verpackung **0,058m³ - 6,1Kg**



Col. 01
Nero
Black
Schwarz



Col. 07
Grigio metallizzato
Metallic grey
Metallic grau



Col. 44
Nichelato
Nickled
Vernickelt

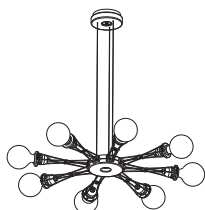

Cod. 385
Matrix Otto

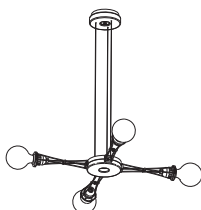

Cod. 386
Matrix Quattro

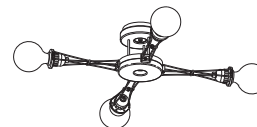

Cod. 388
Matrix Quattro/P

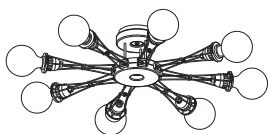

Cod. 389
Matrix Otto/P



Cod. 393 - 394
Matrix Terra

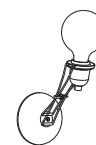

Cod. 395 - 396
Matrix Mono - Matrix Mono/I

Matrix Bulbs cod. 391

8 - Unit box

Eight incandescent light bulbs.
40W E27 CLEAR ø125mm
Not covered by guarantees.
Available until sellout.

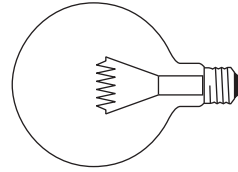

Imballo - Packaging - Verpackung **0,06m³ - 2,08Kg**

Matrix Bulbs cod. 392

8 - Unit box

Eight halogen lamps.
28W energy saver E27 CLEAR ø125mm
Not covered by guarantees.

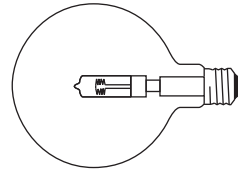

Imballo - Packaging - Verpackung **0,06m³ - 2,08Kg**
